

ELOXIRAS® CONCEPT

July 2019

Specifications

ELOXIRAS® is an innovative process for the treatment and reuse of marine and brackish water. It is developed to enhance the productivity and to reduce the environmental impact of the Recirculating Aquaculture Systems (RAS).

ELOXIRAS® Concept Models:
 - MINI Concept
 - HYBRID Concept

Functionalities

Pre-treatment	Not included
Feed pump	Not included
ELOXIRAS® reactor	➔
Cleaning system	➔
Post-treatment*	➔
Electrical control cabinet	➔
Manual valves	➔
System for protection against moisture and splash	Optional

*Degasser unit not included.

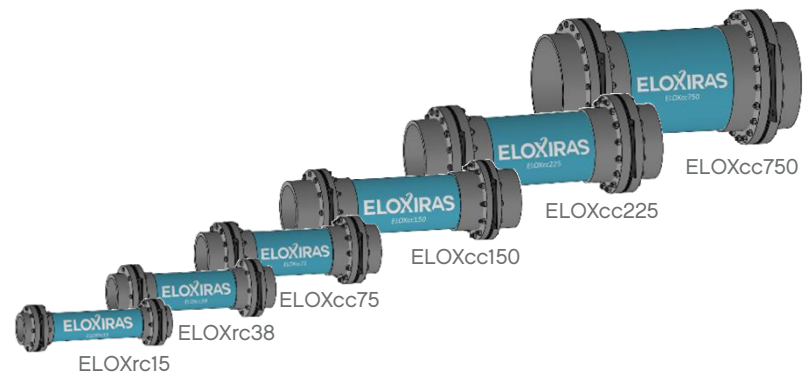

Standard models

Model	ELOXIRAS® reactor model	Tank volume (m ³)	Flowrate (m ³ /h)	Max. TAN removal rate (g TAN/day)*	Disinfection capacity	Energy consumption (kWh/g TAN)
MINI-30	1 x ELOXrc2	1	1 – 2	38	> 3 log	0.04
MINI-150	1 x ELOXrc15	5	5 – 10	192		
MINI-300	1 x ELOXrc15	10	10 – 20	360		
MINI-600	1 x ELOXrc38	20	20 – 40	720		
HYBRID-1500	2 x ELOXcc75	50	50 – 100	1,800		
HYBRID-3000	2 x ELOXcc150	100	100 – 200	3,600		
HYBRID-6000	2 x ELOXcc225	200	200 – 400	7,200		
HYBRID-12000	4 x ELOXcc225	400	400 – 800	14,400		
HYBRID-18000	2 x ELOXcc750	600	600 – 1,200	21,600		

*Value estimated considering the pretreatment step recommended by APRIA Systems.

O&M costs

Model	Energy consumption	Post-treatment regeneration	Reactor cleaning system	Reactor maintenance*
MINI-30	17%	7%	-	76%
MINI-150	22%	8%	-	70%
MINI-300	34%	13%	-	53%
MINI-600	39%	15%	-	46%
HYBRID-1500	51%	20%	3%	26%
HYBRID-3000	54%	21%	3%	22%
HYBRID-6000	57%	22%	3%	18%
HYBRID-12000	57%	22%	3%	18%
HYBRID-18000	57%	22%	3%	18%

*Value based on a lifetime of 2 years.



ELOXIRAS® 4.0

July 2019

Specifications

ELOXIRAS® is an innovative process for the treatment and reuse of marine and brackish water. It is developed to enhance the productivity and to reduce the environmental impact of the Recirculating Aquaculture Systems (RAS).

ELOXIRAS® 4.0 Models:

- MINI 4.0*
- HYBRID 4.0

Functionalities

Pre-treatment	➔
ELOXIRAS® reactor	➔
Cleaning system	➔
Post-treatment	➔
Electrical control cabinet with PLC	➔
Automatic valves	➔
ORP monitoring	➔
pH monitoring	➔
Total chlorine monitoring	➔
Remote monitoring & operation	➔

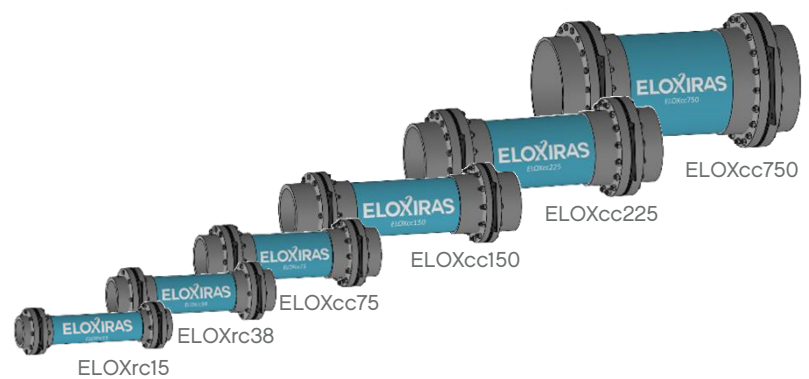

Standard models

Model	ELOXIRAS® reactor model	Tank volume (m³)	Flowrate (m³/h)	Max. TAN removal rate (g TAN/day)*	Disinfection capacity	Energy consumption (kWh/g TAN)
MINI-30	1 x ELOXrc2	1	1 – 2	38	> 3 log	0.34
MINI-150	1 x ELOXrc15	5	5 – 10	192		0.20
MINI-300	1 x ELOXrc15	10	10 – 20	360		0.17
MINI-600	1 x ELOXrc38	20	20 – 40	720		0.17
HYBRID-1500	2 x ELOXcc75	50	50 – 100	1,800		0.16
HYBRID-3000	2 x ELOXcc150	100	100 – 200	3,600		0.13
HYBRID-6000	2 x ELOXcc225	200	200 – 400	7,200		0.13
HYBRID-12000	4 x ELOXcc225	400	400 – 800	14,400		0.13
HYBRID-18000	2 x ELOXcc750	600	600 – 1,200	21,600		0.13

O&M costs

Model	Energy consumption	Post-treatment regeneration	Reactor cleaning system	Reactor maintenance*
MINI-30	65%	3%	-	32%
MINI-150	60%	4%	-	36%
MINI-300	70%	6%	-	24%
MINI-600	75%	6%	-	19%
HYBRID-1500	82%	10%	1%	7%
HYBRID-3000	80%	9%	2%	9%
HYBRID-6000	82%	9%	2%	7%
HYBRID-12000	82%	9%	2%	7%
HYBRID-18000	83%	9%	2%	6%

*Value based on a lifetime of 2 years.

APRIA Systems

Parque Empresarial de Morero, Parcela P.2-12, Nave 1, Puerta 5, 39611, Guarnizo, Cantabria, Spain – Phone: (+34) 942 078147 – e-mail: comercial@apriasystems.es

www.eloxiras.com



ELOXIRAS® MINI 4.0 SERIES

ELOXIRAS® MINI-30-4.0

July 2019

Specifications

ELOXIRAS® MINI Series are designed for small scale RAS (Recirculating Aquaculture Systems) facilities. It offers compactness and adaptable treatment capacity.

ELOXIRAS® MINI 4.0 Models allow the remote control via a web browser.



Tank volume (m ³)	Max. treatment capacity (kg feed/day)	Flowrate (m ³ /h)
1	1	1 – 2

Other ELOXIRAS® Models:

- MINI Concept
- MINI Basic
- MINI Comfort
- HYBRID Concept
- HYBRID 4.0

Functionalities

Pre-treatment	➔
ELOXIRAS® reactor -ELOXrc2-	➔
Cleaning system	➔
Post-treatment	➔
Electrical control cabinet with PLC	➔
Automatic valves	➔
ORP monitoring	➔
pH monitoring	➔
TAN monitoring	Optional
Total chlorine monitoring	➔
Temperature control system	Optional
Oxygenation system	Optional
Consumption analysis	Optional
Remote monitoring & operation	➔

Dimensions

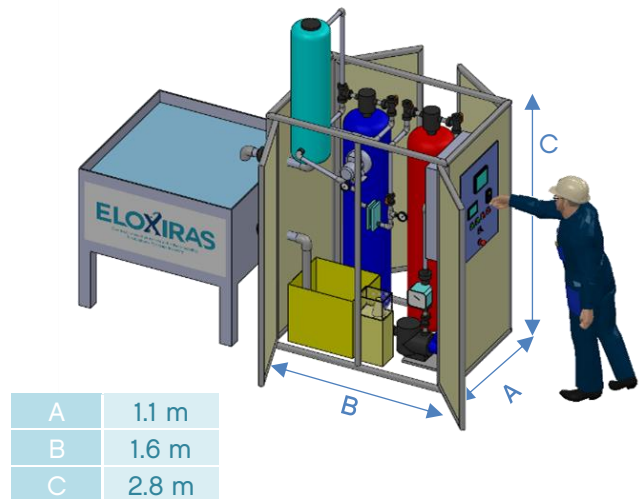

Estimated footprint: 1.8 m²

O&M costs

	O&M costs*
Energy consumption	65%
Post-treatment regeneration	3%
Reactor cleaning system	-
Reactor maintenance**	32%

*Software license cost not included.

**Value based on a lifetime of 2 years.

Proven technology

ELOXIRAS® MINI-30-4.0 is designed to provide flexibility with an immediate response to water treatment requirements. High TAN removal - with no significant nitrate accumulation - and disinfection efficacies are achieved.

- TAN removal rate: - > 90% per pass - 38 g TAN/day
- Disinfection capacity: > 3 log
- Water exchange rate: 200 – 480 L/kg feed
- Energy consumption: 0.34 kWh/g TAN*

* Lower values using other models: e.g. 0.13 kWh/gTAN

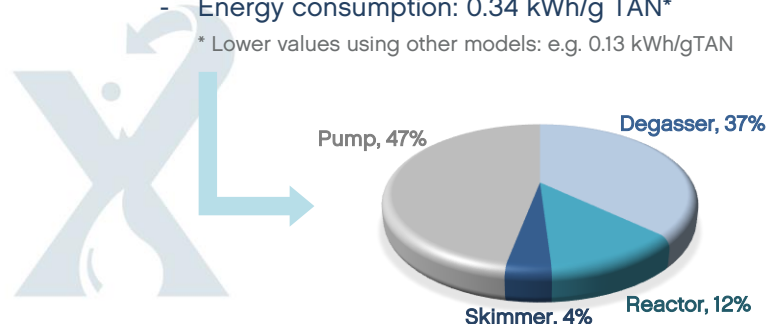

APRIA Systems

ELOXIRAS® MINI 4.0 SERIES

ELOXIRAS® MINI-150-4.0

July 2019

Specifications

ELOXIRAS® MINI Series are designed for small scale RAS (Recirculating Aquaculture Systems) facilities. It offers compactness and adaptable treatment capacity.

ELOXIRAS® MINI 4.0 Models allow the remote control via a web browser.



Tank volume (m ³)	Max. treatment capacity (kg feed/day)	Flowrate (m ³ /h)
5	5	5 – 10

Other ELOXIRAS® Models:

- MINI Concept
- MINI Basic
- MINI Comfort
- HYBRID Concept
- HYBRID 4.0

Functionalities

Pre-treatment	➔
ELOXIRAS® reactor -ELOXrc15-	➔
Cleaning system	➔
Post-treatment	➔
Electrical control cabinet with PLC	➔
Automatic valves	➔
ORP monitoring	➔
pH monitoring	➔
TAN monitoring	Optional
Total chlorine monitoring	➔
Temperature control system	Optional
Oxygenation system	Optional
Consumption analysis	Optional
Remote monitoring & operation	➔

Dimensions

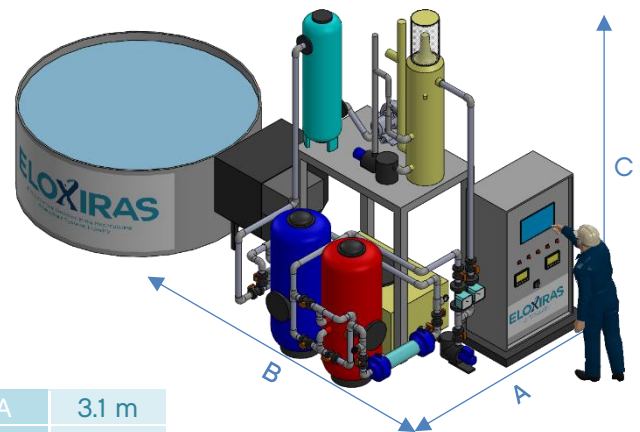

A	3.1 m
B	2.5 m
C	4.1 m

Estimated footprint: 7.8 m²

O&M costs

	O&M costs*
Energy consumption	60%
Post-treatment regeneration	4%
Reactor cleaning system	-
Reactor maintenance**	36%

*Software license cost not included.

**Value based on a lifetime of 2 years.

Proven technology

ELOXIRAS® MINI-150-4.0 is designed to provide flexibility with an immediate response to water treatment requirements. High TAN removal - with no significant nitrate accumulation - and disinfection efficacies are achieved.

- TAN removal rate: - > 90% per pass - 192 g TAN/day
- Disinfection capacity: > 3 log
- Water exchange rate: 200 – 480 L/kg feed
- Energy consumption: 0.20 kWh/g TAN*

* Lower values using other models: e.g. 0.13 kWh/gTAN

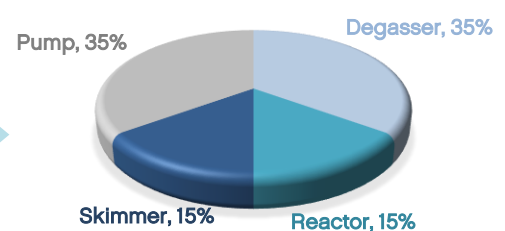

ELOXIRAS® MINI 4.0 SERIES

ELOXIRAS® MINI-300-4.0

July 2019

Specifications

ELOXIRAS® MINI Series are designed for small scale RAS (Recirculating Aquaculture Systems) facilities. It offers compactness and adaptable treatment capacity.

ELOXIRAS® MINI 4.0 Models allow the remote control via a web browser.



Tank volume (m ³)	Max. treatment capacity (kg feed/day)	Flowrate (m ³ /h)
10	15	10 – 20

Other ELOXIRAS® Models:

- MINI Concept
- MINI Basic
- MINI Comfort
- HYBRID Concept
- HYBRID 4.0

Functionalities

Pre-treatment	➔
ELOXIRAS® reactor -ELOXrc15-	➔
Cleaning system	➔
Post-treatment	➔
Electrical control cabinet with PLC	➔
Automatic valves	➔
ORP monitoring	➔
pH monitoring	➔
TAN monitoring	Optional
Total chlorine monitoring	➔
Temperature control system	Optional
Oxygenation system	Optional
Consumption analysis	Optional
Remote monitoring & operation	➔

Dimensions

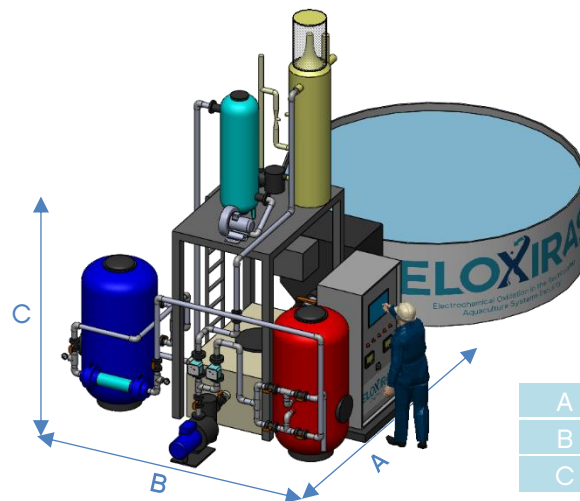

A	4.3 m
B	3.1 m
C	5.0 m

Estimated footprint: 13.3 m²

O&M costs

	O&M costs*
Energy consumption	70%
Post-treatment regeneration	6%
Reactor cleaning system	-
Reactor maintenance**	24%

*Software license cost not included.

**Value based on a lifetime of 2 years.

Proven technology

ELOXIRAS® MINI-300-4.0 is designed to provide flexibility with an immediate response to water treatment requirements. High TAN removal - with no significant nitrate accumulation - and disinfection efficacies are achieved.

- TAN removal rate: - > 90% per pass - 360 g TAN/day
- Disinfection capacity: > 3 log
- Water exchange rate: 200 – 480 L/kg feed
- Energy consumption: 0.17 kWh/g TAN*

* Lower values using other models: e.g. 0.13 kWh/gTAN

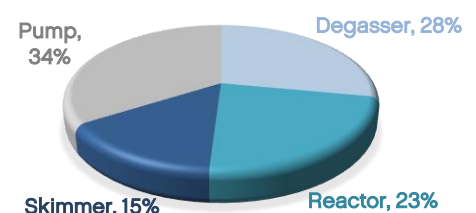
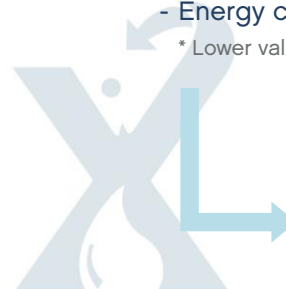

ELOXIRAS® MINI 4.0 SERIES

ELOXIRAS® MINI-600-4.0

July 2019

Specifications

ELOXIRAS® MINI Series are designed for small scale RAS (Recirculating Aquaculture Systems) facilities. It offers compactness and adaptable treatment capacity.

ELOXIRAS® MINI 4.0 Models allow the remote control via a web browser.



Tank volume (m ³)	Max. treatment capacity (kg feed/day)	Flowrate (m ³ /h)
20	30	20 – 40

Other ELOXIRAS® Models:

- MINI Concept
- MINI Basic
- MINI Comfort
- HYBRID Concept
- HYBRID 4.0

Functionalities

Pre-treatment	➔
ELOXIRAS® reactor -ELOXrc38-	➔
Cleaning system	➔
Post-treatment	➔
Electrical control cabinet with PLC	➔
Automatic valves	➔
ORP monitoring	➔
pH monitoring	➔
TAN monitoring	Optional
Total chlorine monitoring	➔
Temperature control system	Optional
Oxygenation system	Optional
Consumption analysis	Optional
Remote monitoring & operation	➔

Dimensions

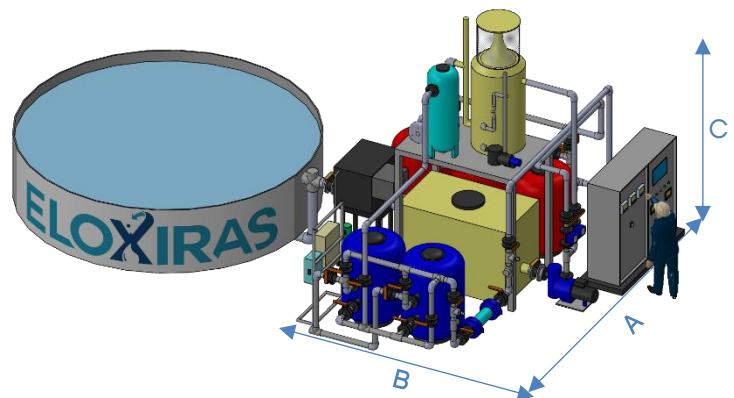

A	6.2 m
B	5.2 m
C	4.9 m

Estimated footprint: 32.2 m²

O&M costs

	O&M costs*
Energy consumption	75%
Post-treatment regeneration	6%
Reactor cleaning system	-
Reactor maintenance**	19%

*Software license cost not included.

**Value based on a lifetime of 2 years.

Proven technology

ELOXIRAS® MINI-600-4.0 is designed to provide flexibility with an immediate response to water treatment requirements. High TAN removal - with no significant nitrate accumulation - and disinfection efficacies are achieved.

- TAN removal rate: - > 90% per pass - 720 g TAN/day
- Disinfection capacity: > 3 log
- Water exchange rate: 200 – 480 L/kg feed
- Energy consumption: 0.17 kWh/g TAN*

* Lower values using other models: e.g. 0.13 kWh/gTAN

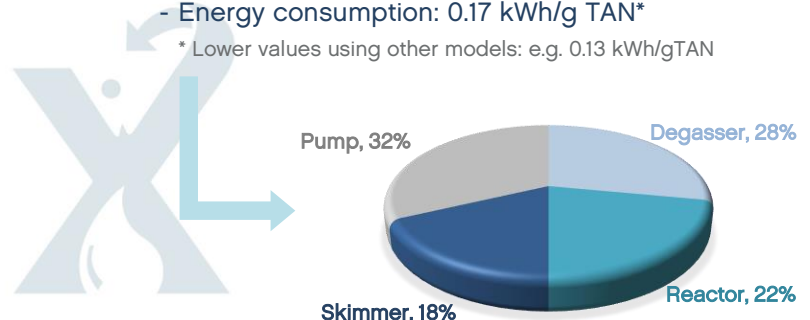

APRIA Systems

ELOXIRAS® HYBRID 4.0 SERIES

ELOXIRAS® HYBRID-1500-4.0

July 2019

Specifications

ELOXIRAS® HYBRID Series are designed for the treatment and reuse of marine and brackish water at large RAS (Recirculating Aquaculture Systems).

ELOXIRAS® HYBRID 4.0 Models allow the remote control via a web browser.



Tank volume (m ³)	Max. treatment capacity (kg feed/day)	Flowrate (m ³ /h)
50	50	50 – 100

Other ELOXIRAS® Models:

- HYBRID Concept
- MINI Concept
- MINI Basic
- MINI Comfort
- MINI 4.0

Functionalities

Pre-treatment	➔
ELOXIRAS® reactor -ELOXcc75-	➔
Cleaning system	➔
Post-treatment	➔
Electrical control cabinet with PLC	➔
Automatic valves	➔
ORP monitoring	➔
pH monitoring	➔
TAN monitoring	Optional
Total chlorine monitoring	➔
Temperature control system	Optional
Oxygenation system	Optional
Consumption analysis	Optional
Remote monitoring & operation	➔

Dimensions

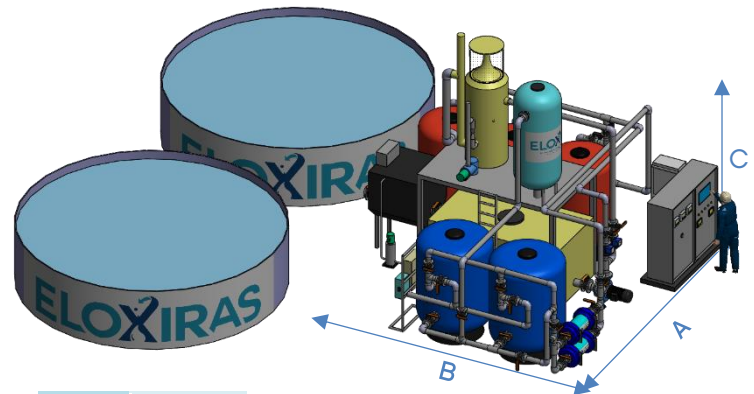

A	7.4 m
B	6.7 m
C	5.3 m

Estimated footprint: 49.6 m²

O&M costs

	O&M costs*
Energy consumption	82%
Post-treatment regeneration	10%
Reactor cleaning system	1%
Reactor maintenance*	7%

*Software license cost not included.

**Value based on a lifetime of 2 years.

Proven technology

ELOXIRAS® HYBRID-1500-4.0 contributes to increase the production capacity, as well as to decrease the environmental impacts. High TAN removal and disinfection capacities are achieved.

- TAN removal rate: - > 90% per pass - 1,800 g TAN/day
- Disinfection capacity: > 3 log
- Water exchange rate: 200 – 480 L/kg feed
- Energy consumption: 0.16 kWh/g TAN*

* Lower values using other models: e.g. 0.13 kWh/gTAN

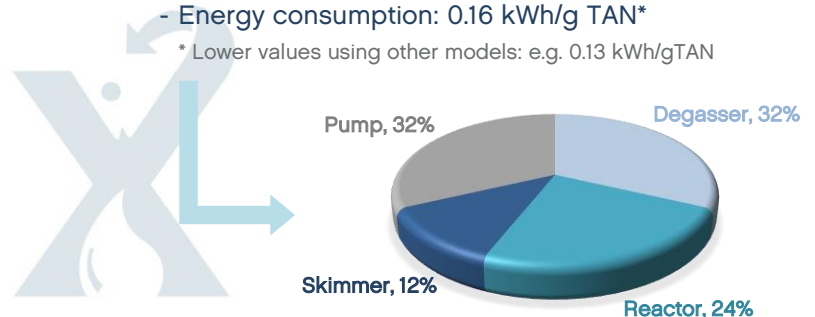

APRIA Systems

ELOXIRAS® HYBRID 4.0 SERIES

ELOXIRAS® HYBRID-3000-4.0

July 2019

Specifications

ELOXIRAS® HYBRID Series are designed for the treatment and reuse of marine and brackish water at large RAS (Recirculating Aquaculture Systems).

ELOXIRAS® HYBRID 4.0 Models allow the remote control via a web browser.



Other ELOXIRAS® Models:

- HYBRID Concept
- MINI Concept
- MINI Basic
- MINI Comfort
- MINI 4.0

Tank volume (m ³)	Max. treatment capacity (kg feed/day)	Flowrate (m ³ /h)
100	100	100 – 200

Functionalities

Pre-treatment	➔
ELOXIRAS® reactor -ELOXcc150-	➔
Cleaning system	➔
Post-treatment	➔
Electrical control cabinet with PLC	➔
Automatic valves	➔
ORP monitoring	➔
pH monitoring	➔
TAN monitoring	Optional
Total chlorine monitoring	➔
Temperature control system	Optional
Oxygenation system	Optional
Consumption analysis	Optional
Remote monitoring & operation	➔

Dimensions

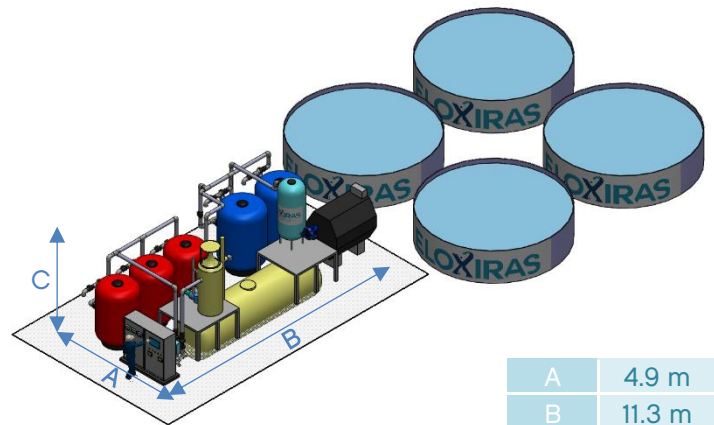

A	4.9 m
B	11.3 m
C	4.2 m

Estimated footprint: 55.4 m²

O&M costs

	O&M costs*
Energy consumption	80%
Post-treatment regeneration	9%
Reactor cleaning system	2%
Reactor maintenance*	9%

*Software license cost not included.

**Value based on a lifetime of 2 years.

Proven technology

ELOXIRAS® HYBRID-3000-4.0 contributes to increase the production capacity, as well as to decrease the environmental impacts. High TAN removal and disinfection capacities are achieved.

- TAN removal rate: - > 90% per pass - 3,600 g TAN/day
- Disinfection capacity: > 3 log
- Water exchange rate: 200 – 480 L/kg feed
- Energy consumption: 0.13 kWh/g TAN*

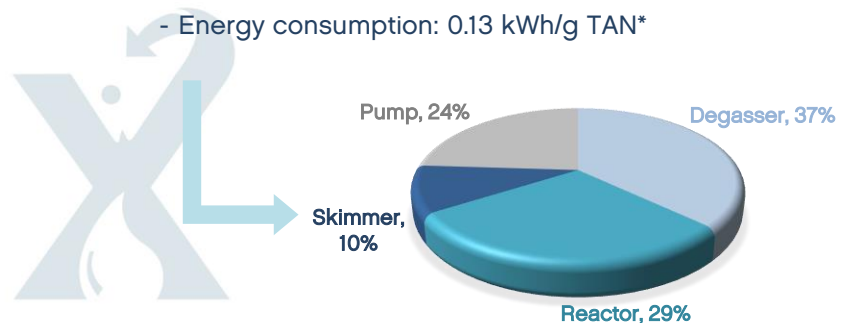

APRIA Systems

ELOXIRAS® HYBRID 4.0 SERIES

ELOXIRAS® HYBRID-6000-4.0

July 2019

Specifications

ELOXIRAS® HYBRID Series are designed for the treatment and reuse of marine and brackish water at large RAS (Recirculating Aquaculture Systems).

ELOXIRAS® HYBRID 4.0 Models allow the remote control via a web browser.



Tank volume (m ³)	Max treatment capacity (kg feed/day)	Flowrate (m ³ /h)
200	200	200 – 400

Other ELOXIRAS® Models:

- HYBRID Concept
- MINI Concept
- MINI Basic
- MINI Comfort
- MINI 4.0

Functionalities

Pre-treatment	➔
ELOXIRAS® reactor -ELOXcc225-	➔
Cleaning system	➔
Post-treatment	➔
Electrical control cabinet with PLC	➔
Automatic valves	➔
ORP monitoring	➔
pH monitoring	➔
TAN monitoring	Optional
Total chlorine monitoring	➔
Temperature control system	Optional
Oxygenation system	Optional
Consumption analysis	Optional
Remote monitoring & operation	➔

Dimensions

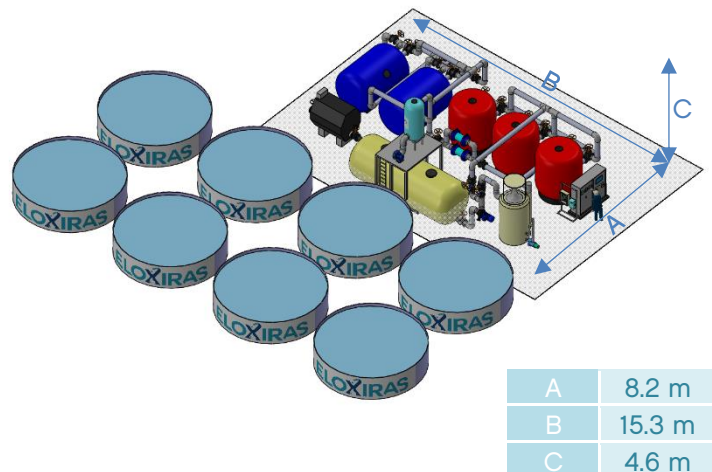

Estimated footprint: 126 m²

O&M costs

	O&M costs*
Energy consumption	82%
Post-treatment regeneration	9%
Reactor cleaning system	2%
Reactor maintenance*	7%

*Software license cost not included.

**Value based on a lifetime of 2 years.

Proven technology

ELOXIRAS® HYBRID-6000-4.0 contributes to increase the production capacity, as well as to decrease the environmental impacts. High TAN removal and disinfection capacities are achieved.

- TAN removal rate: - > 90% per pass - 7,200 g TAN/day
- Disinfection capacity: > 3 log
- Water exchange rate: 200 – 480 L/kg feed
- Energy consumption: 0.13 kWh/g TAN*

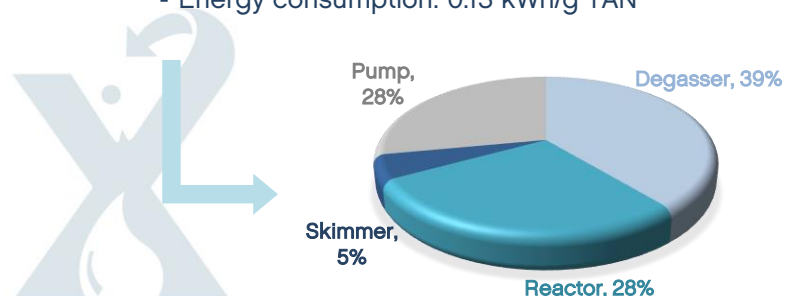

APRIA Systems

ELOXIRAS® HYBRID 4.0 SERIES

ELOXIRAS® HYBRID-12000-4.0

July 2019

Specifications

ELOXIRAS® HYBRID Series are designed for the treatment and reuse of marine and brackish water at large RAS (Recirculating Aquaculture Systems).

ELOXIRAS® HYBRID 4.0 Models allow the remote control via a web browser.



Other ELOXIRAS® Models:

- HYBRID Concept
- MINI Concept
- MINI Basic
- MINI Comfort
- MINI 4.0

Tank volume (m ³)	Max treatment capacity (kg feed/day)	Flowrate (m ³ /h)
400	400	400 – 800

Functionalities

Pre-treatment	➔
ELOXIRAS® reactor -ELOXcc225-	➔
Cleaning system	➔
Post-treatment	➔
Electrical control cabinet with PLC	➔
Automatic valves	➔
ORP monitoring	➔
pH monitoring	➔
TAN monitoring	Optional
Total chlorine monitoring	➔
Temperature control system	Optional
Oxygenation system	Optional
Consumption analysis	Optional
Remote monitoring & operation	➔

Dimensions

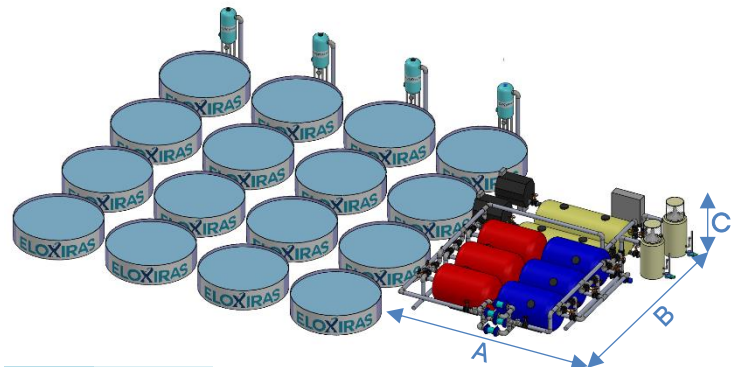

A	14 m
B	18 m
C	4 m

Estimated footprint: 252 m²

O&M costs

	O&M costs*
Energy consumption	82%
Post-treatment regeneration	9%
Reactor cleaning system	2%
Reactor maintenance*	7%

*Software license cost not included.

**Value based on a lifetime of 2 years.

Proven technology

ELOXIRAS® HYBRID-12000-4.0 contributes to increase the production capacity, as well as to decrease the environmental impacts. High TAN removal and disinfection capacities are achieved.

- TAN removal rate: - > 90% per pass - 14,400 g TAN/day
- Disinfection capacity: > 3 log
- Water exchange rate: 200 – 480 L/kg feed
- Energy consumption: 0.13 kWh/g TAN*

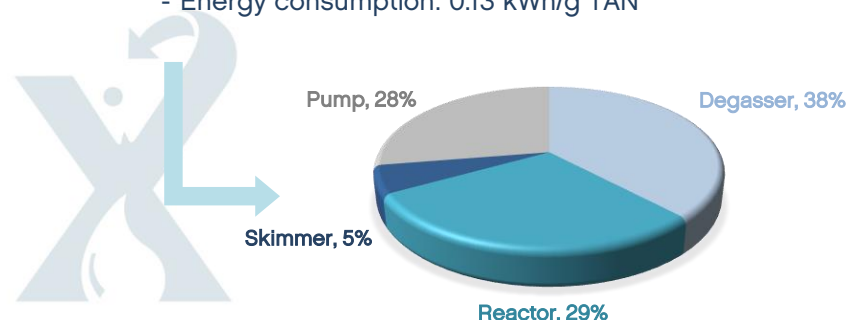

APRIA Systems

ELOXIRAS® HYBRID 4.0 SERIES

ELOXIRAS® HYBRID-18000-4.0

July 2019

Specifications

ELOXIRAS® HYBRID Series are designed for the treatment and reuse of marine and brackish water at large RAS (Recirculating Aquaculture Systems).

ELOXIRAS® HYBRID 4.0 Models allow the remote control via a web browser.



Other ELOXIRAS® Models:

- HYBRID Concept
- MINI Concept
- MINI Basic
- MINI Comfort
- MINI 4.0

Tank volume (m ³)	Max treatment capacity (kg feed/day)	Flowrate (m ³ /h)
600	600	600 – 1,200

Functionalities

Pre-treatment	➔
ELOXIRAS® reactor -ELOXcc750-	➔
Cleaning system	➔
Post-treatment	➔
Electrical control cabinet with PLC	➔
Automatic valves	➔
ORP monitoring	➔
pH monitoring	➔
TAN monitoring	Optional
Total chlorine monitoring	➔
Temperature control system	Optional
Oxygenation system	Optional
Consumption analysis	Optional
Remote monitoring & operation	➔

Dimensions

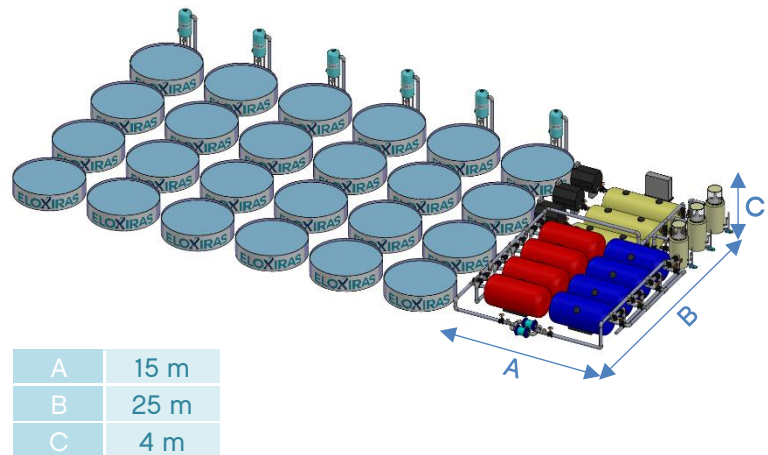

Estimated footprint: 375 m²

O&M costs

	O&M costs*
Energy consumption	83%
Post-treatment regeneration	9%
Reactor cleaning system	2%
Reactor maintenance*	6%

*Software license cost not included.

**Value based on a lifetime of 2 years.

Proven technology

ELOXIRAS® HYBRID-18000-4.0 contributes to increase the production capacity, as well as to decrease the environmental impacts. High TAN removal and disinfection capacities are achieved.

- TAN removal rate: - > 90% per pass - 21,600 g TAN/day
- Disinfection capacity: > 3 log
- Water exchange rate: 200 – 480 L/kg feed
- Energy consumption: 0.13 kWh/g TAN*

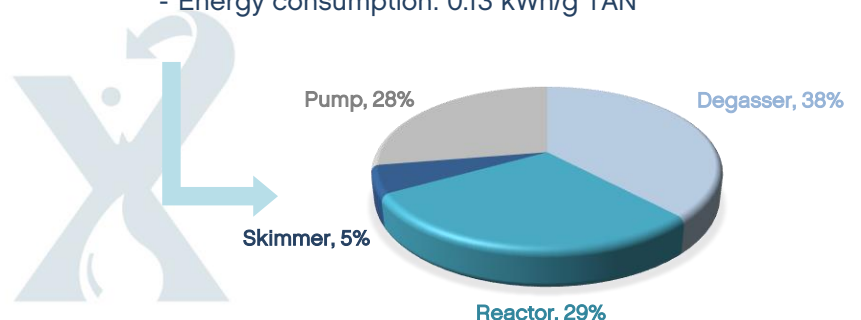

APRIA Systems